

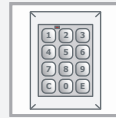

> INFORMAÇÕES TÉCNICAS



Prata
Preta



Teclado
inteligente

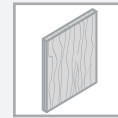

Para painéis
de madeira



Espessura
mínima de
15mm



Indicado para
gavetas



Indicado para
portas batentes



Dispositivo
de trava



Alimentação
pilhas alcalina
AA 1,5V

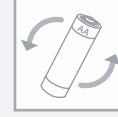

É possível
substituir
as pilhas

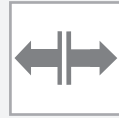

Ambidestro



Não é indicado
para portas de
correr

> INSTRUÇÕES DE MONTAGEM



Animação de
montagem
disponível
no site

> MEDIDAS DE INSTALAÇÃO

Teclado M400

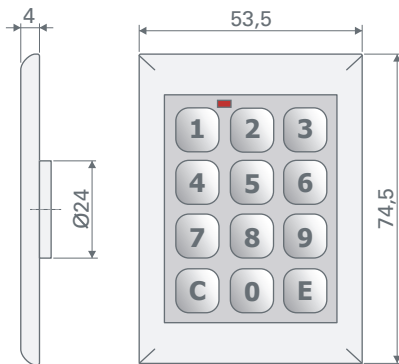

Contra fecho

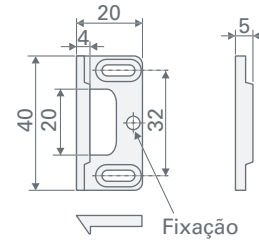

Para instalação em gavetas é indicado que a fechadura seja colocada no centro do móvel. Quando não for possível o teclado pode ser deslocado para o lado, porém será necessário o uso de cabos prolongadores.



Fechadura eletrônica M400

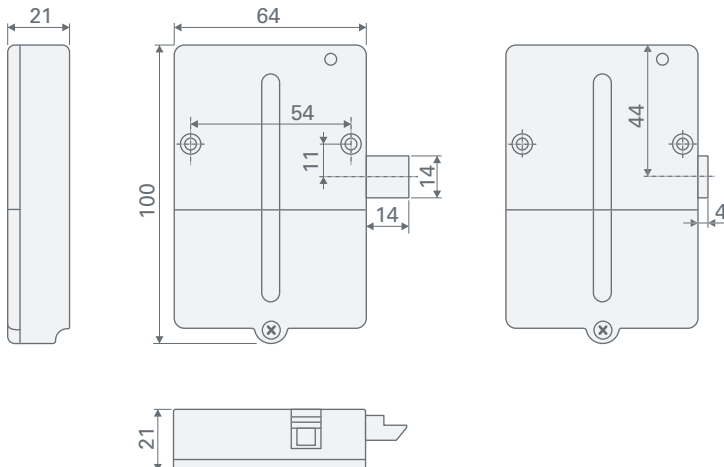

> COMPONENTES



CÓDIGO DESCRIÇÃO

83040130101 Conjunto de fechadura eletrônica Lehmann M400TA composto por teclado cor preta, pilhas AA, cabo conector, contra fecho e parafusos de fixação.



Unitário



CÓDIGO DESCRIÇÃO

83040130102 Conjunto de fechadura eletrônica Lehmann M400TA composto por teclado cor prata, pilhas AA, cabo conector, contra fecho e parafusos de fixação.



Unitário