

GIVI MOBILI ACESSÓRIOS PARA MÓVEIS LTDA.

Rua João Bettega, 4.800, Módulo V - CEP 81350-000 - CIC - Curitiba - PR

Fone: (41) 3906-8080 FAX: (41) 3906-8008

www.givimobili.com.br

TAMBOR PARA UNIÃO E FIXAÇÃO DE PAINÉIS

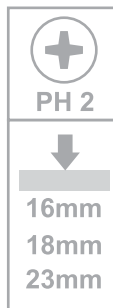
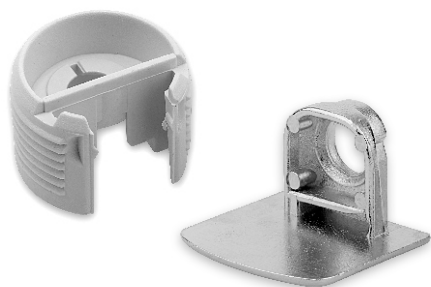

- Montagem em conjunto com suporte metálico
- Suporte para prateleiras

Componentes



1x Tambor plástico branco

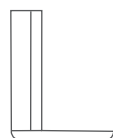

1x Suporte em Zamak

Medidas básicas

Tambor:

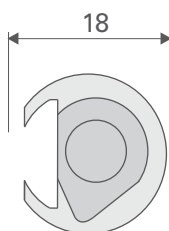

Espessura do painel	Altura do tambor
16	13
18	14,2
23	17

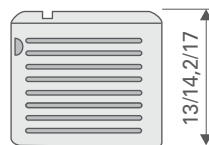

Medidas de usinagem para o tambor:

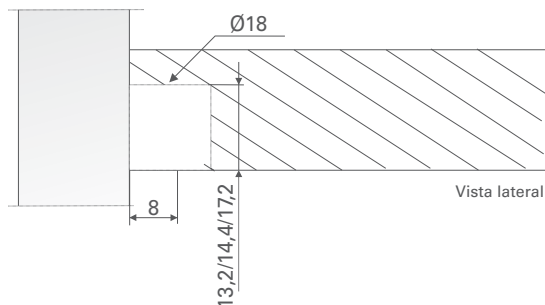

Fixação do tambor

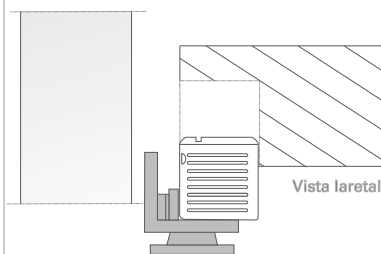

Indica-se a utilização de gabarito para a fixação do tambor no painel

O tambor possui ranhuras nas laterais que possibilitam a fixação sob pressão, sem a utilização de parafuso.

O gabarito é um acessório opcional, não acompanha o sistema  ATENÇÃO

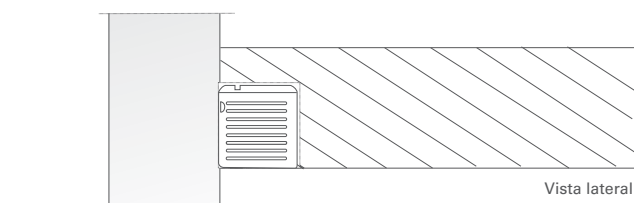

Suporte:



Medidas de usinagem para o suporte:

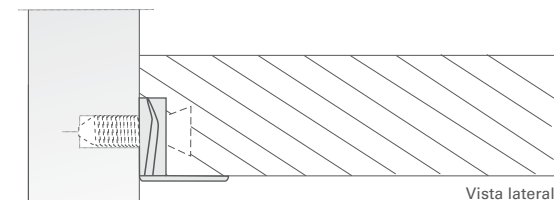
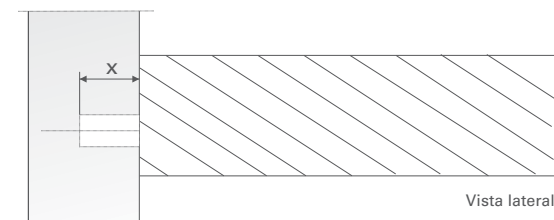

Parafuso não acompanha o sistema  ATENÇÃO

Recomenda-se a utilização dos parafusos:



ou



 ATENÇÃO

1 Montagem

Parafuso para madeira Ø4mm 

ou

Parafuso EURO Ø5mm 

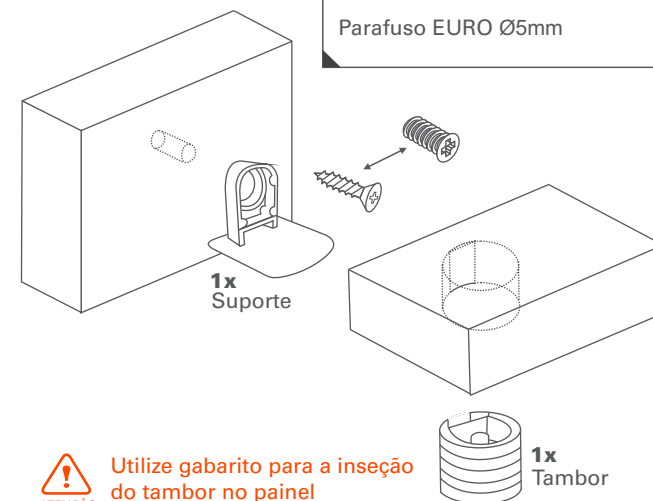

 ATENÇÃO

Utilize gabarito para a inserção do tambor no painel



Após a fixação dos componentes nos painéis, unir o tambor e o suporte através de encaixe

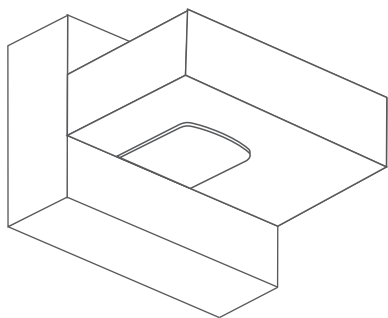

ACESSÓRIOS

ACESSÓRIO OPCIONAL

Gabarito para fixação:

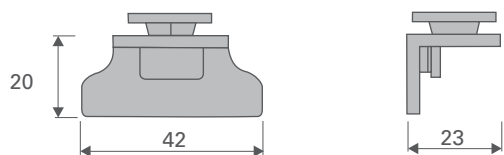

Givi