

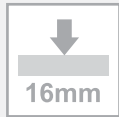

> INFORMAÇÕES TÉCNICAS

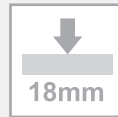

Para painéis de 16mm



Para painéis de 18mm

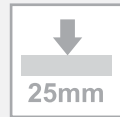

Para painéis de 25mm



Tambor com borda



Chave Phillips 2



Niquelado



Componente em Zamak

> INSTRUÇÕES DE MONTAGEM



Animação de montagem disponível no site

> MEDIDAS DE INSTALAÇÃO

União em L

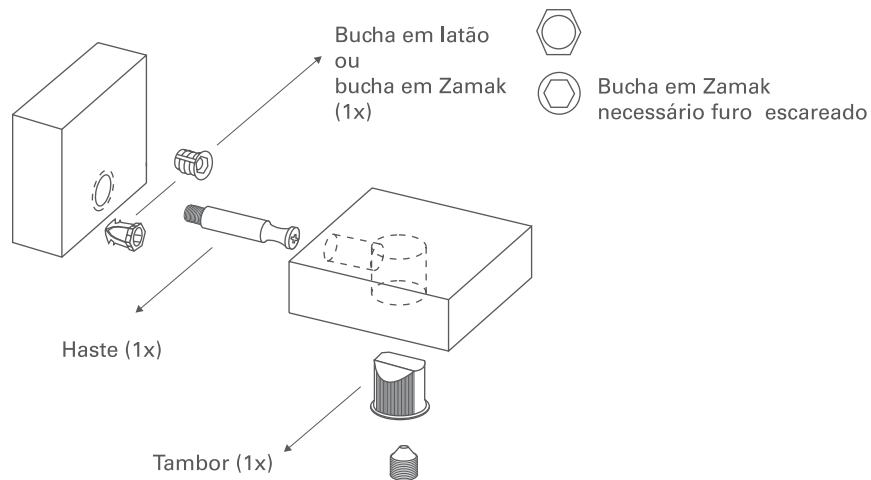

União em T para painel de 16 e 18mm

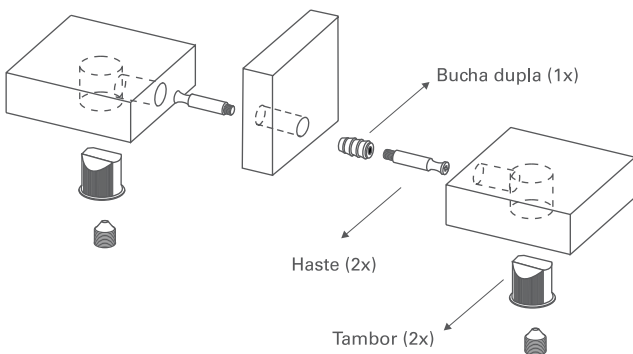

União em T para painel de 25mm

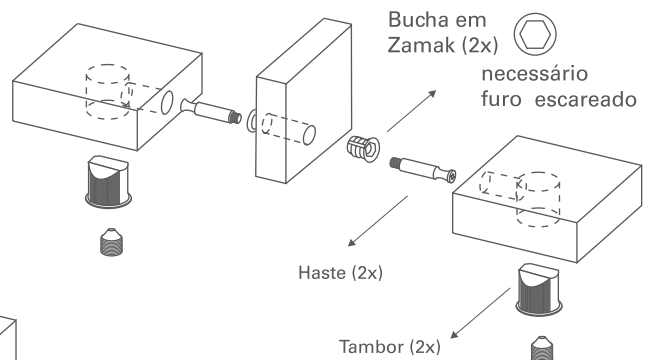

> COMPONENTES

Tambor

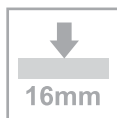
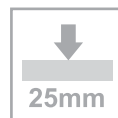
Para painéis
de 16mmPara painéis
de 18mmPara painéis
de 25mmChave
Phillips 2

Niquelado

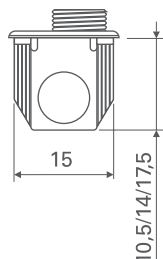

Unitário

CÓDIGO DESCRIÇÃO

83070010065	Tambor com borda niquelado ϕ 15X10,5mm para painel 16mm
83070010076	Tambor com borda niquelado ϕ 15X14mm para painel 18mm
83060010026	Tambor com borda niquelado ϕ 15X17,5mm para painel 25mm

Haste

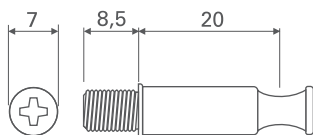

Zincado



Unitário

CÓDIGO DESCRIÇÃO

83070010022	Haste zincada ϕ 7XM6X20mm
-------------	--------------------------------

Bucha dupla

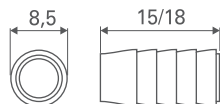
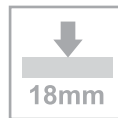
Para painéis
de 16mmPara painéis
de 18mm

Zincado



Unitário

CÓDIGO DESCRIÇÃO

83070010062	Bucha ferro M6X15X8,5mm para furo 8,5mm
83070010030	Bucha ferro M6X18X8,5mm para furo 8,5mm

Bucha em Zamak

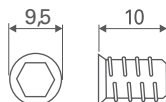

Unitário

CÓDIGO DESCRIÇÃO

83070010032	Bucha allen em zamak ϕ 8XM6X10mm
-------------	---------------------------------------

Bucha em latão

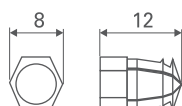

Unitário

CÓDIGO DESCRIÇÃO

83070010033	Bucha hexagonal em latão M6X12X8mm
83070010027	Bucha em latão com pastilha M6X12X8mm para furo 12mm