



> INFORMAÇÕES TÉCNICAS



Para painéis  
de 16mm



Para painéis  
de 18mm



Para painéis  
de 23mm



Chave  
Phillips 2



Branco



Componente  
em Zamak



Componente  
em ABS

> INSTRUÇÕES DE MONTAGEM



Animação de  
montagem  
disponível  
no site

> MEDIDAS DE INSTALAÇÃO

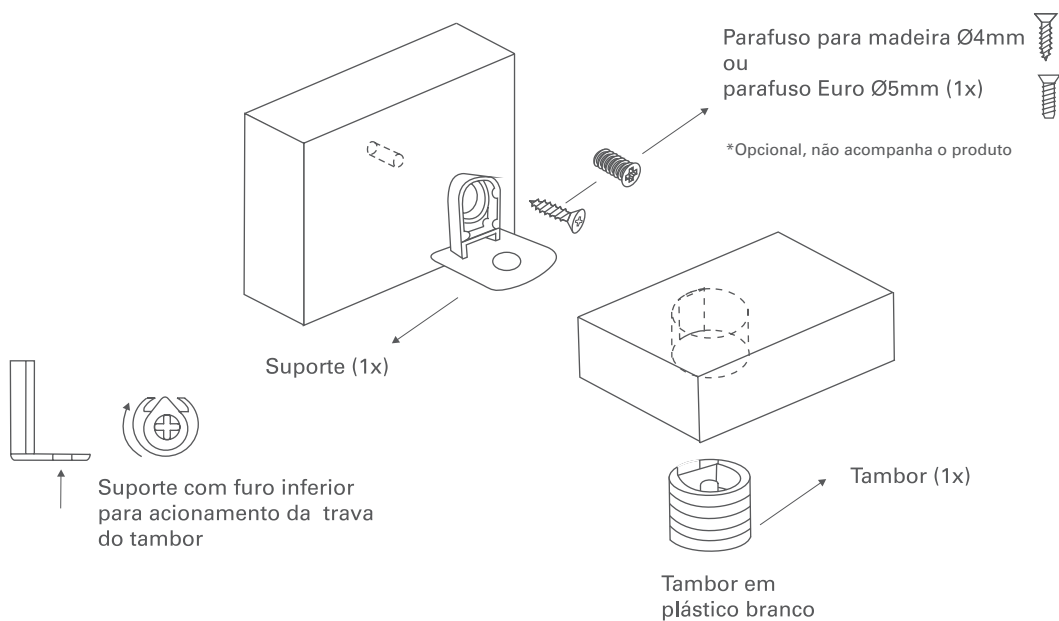

> COMPONENTES

Tambor

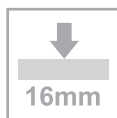
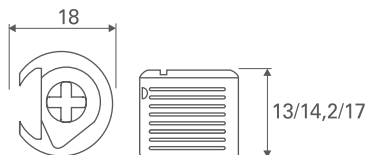

Para painéis  
de 16mm

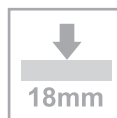

Para painéis  
de 18mm

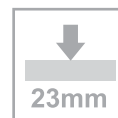

Para painéis  
de 23mm



Componente  
em ABS



Branco



Unitário

CÓDIGO DESCRIÇÃO

83060010015 Tambor branco shelf block Ø18X13mm para 16mm

83060010016 Tambor branco shelf block Ø18X14,2mm para 18/19mm

83060010017 Tambor branco shelf block Ø18X17mm para 23mm

Suporte

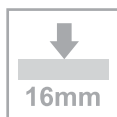
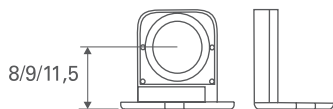

Para painéis  
de 16mm

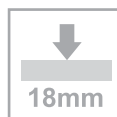

Para painéis  
de 18mm

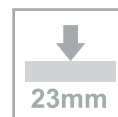

Para painéis  
de 23mm



Niquelado



Unitário

CÓDIGO DESCRIÇÃO

83060010001 Suporte shelf block com trava em zamak niquelado para 16mm

83060010003 Suporte shelf block com trava em zamak niquelado para 18/19mm

83060010005 Suporte shelf block com trava em zamak niquelado para 23mm

06

DISPOSITIVOS DE MONTAGEM

> ACESSÓRIO

Gabarito de inserção

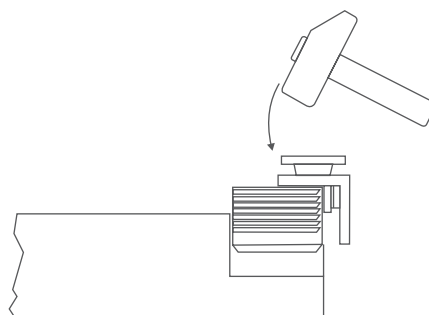
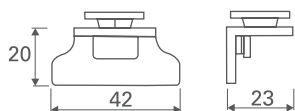

Utilização  
do gabarito



Preto



Unitário

CÓDIGO DESCRIÇÃO

83060010022 Gabarito para tambor plástico shelf fix e shelf block

Parafuso para fixação



Unitário

CÓDIGO DESCRIÇÃO

V234X164 Parafuso niquelado para dobradiças Ø4x16,4mm