

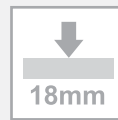

> INFORMAÇÕES TÉCNICAS



Para painéis
de 16mm



Para painéis
de 18mm

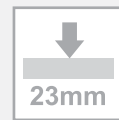

Para painéis
de 23mm



Chave
Phillips 2



Branco



Componente
em Zamak



Componente
em ABS

> INSTRUÇÕES DE MONTAGEM



Animação de
montagem
disponível
no site

> MEDIDAS DE INSTALAÇÃO

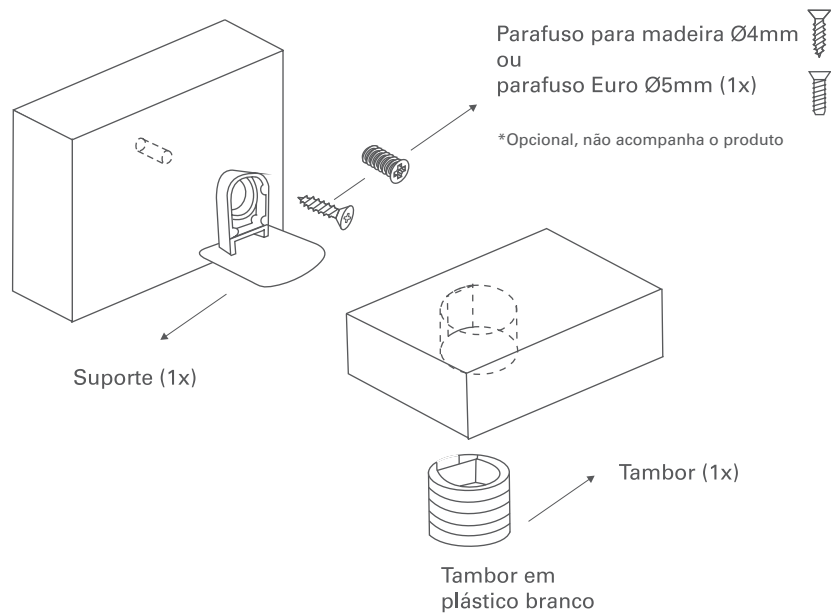

> COMPONENTES

Tambor

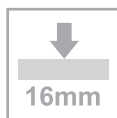
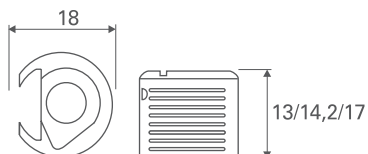

Para painéis
de 16mm

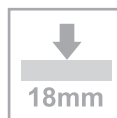

Para painéis
de 18mm

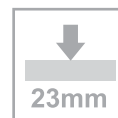

Para painéis
de 23mm



Componente
em ABS



Branco



CÓDIGO DESCRIÇÃO

83060010020	Tambor branco shelf fix Ø18X13mm para 16mm
83060010021	Tambor branco shelf fix Ø18X14,2mm para 18/19mm
83060010019	Tambor branco shelf fix Ø18X17mm para 23mm

Suporte

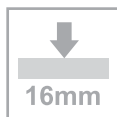
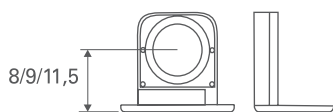
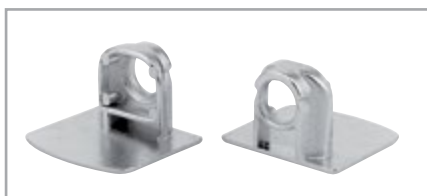

Para painéis
de 16mm

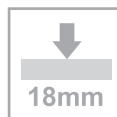

Para painéis
de 18mm

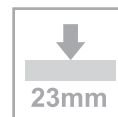

Para painéis
de 23mm



Niquelado



CÓDIGO DESCRIÇÃO

83060010002	Suporte shelf fix em zamak niquelado para 16mm
83060010004	Suporte shelf fix em zamak niquelado para 18/19mm
83060010007	Suporte shelf fix em zamak niquelado para 23mm

06

DISPOSITIVOS DE MONTAGEM

> ACESSÓRIOS

Gabarito de inserção

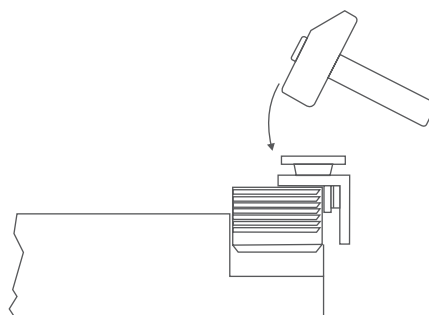
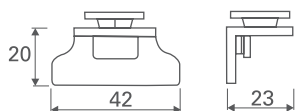

Utilização
do gabarito



Preto



CÓDIGO DESCRIÇÃO

83060010022	Gabarito para tambor plástico shelf fix e shelf block
-------------	---

Parafuso para fixação



CÓDIGO DESCRIÇÃO

V234X164	Parafuso niquelado para dobradiças Ø4x16,4mm
----------	--