

> INFORMAÇÕES TÉCNICAS

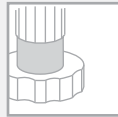

Altura de 150mm



Regulagem - 5 a + 50mm

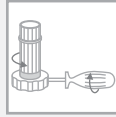

Permite regulagem externa

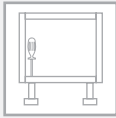

Permite regulagem interna

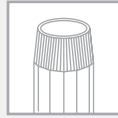

Ø 28mm



Preto



Componente em ABS

> INSTRUÇÕES DE MONTAGEM



Animação de montagem disponível no site

> MEDIDAS DE INSTALAÇÃO



04

NIVELADORES

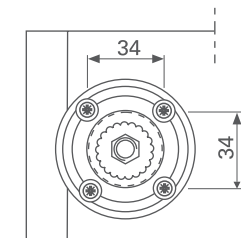
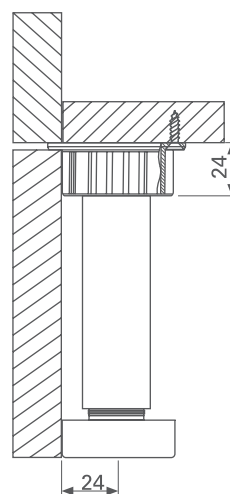
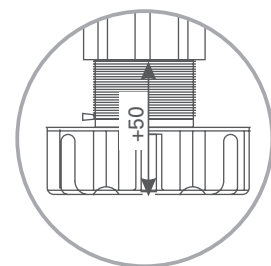
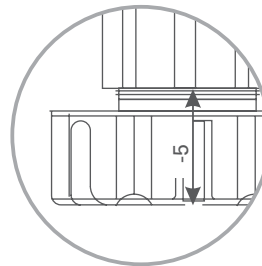
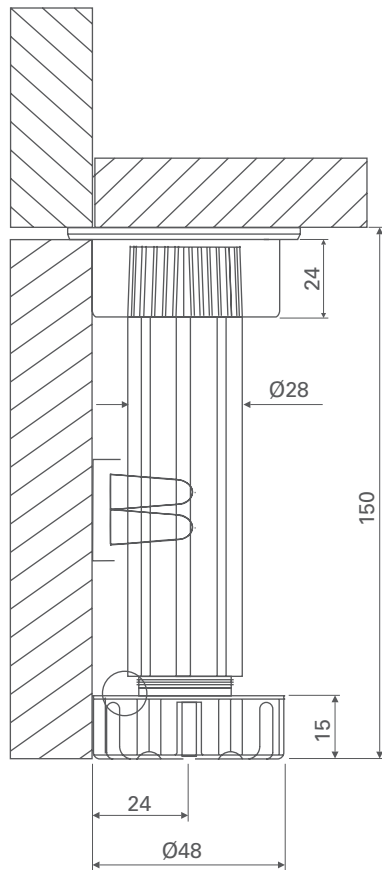

Base:



CÓDIGO	DESCRIÇÃO
83030050004	Pé plástico ø28mm com regulagem +50 a -5mm e altura 150mm
83030050005	Kit pé plástico ø28mm com regulagem +50 a -5mm e altura 150mm e base circular
83030050003	Base circular para pé plástico ø28mm e altura 24mm

